

16499 / VK33-120 S/S LID

Position	ItemNo	Description
01	14579	Feet M8
02	12800	Cover Hinge Right/Left
03	12795	Cover Hinge Axis
04	13169	Strengthening Board
05	13157	Stainless Steel Lid
06	12907	Nut For Cover Hinge Axis
11	11870	Unit Room Cover For Compressor
12	15722	Filter Drier 20 G
13	13237	Defrost Water Coil
14	14193	Condensor
15	10068	Plastic Cap
16	11621	Unit Side Nordcap
17	32629	Plug
20	13318	Cond./Evap. Fan Rah1238B
21	11725	Compressor HDL100A R600A
	11726	Compressor HDL140A R600
	11734	Compressor HXD55AA R600A
23	13754	Main Switch
24	14061	Thermostat XR02CX 2 Probes
26	14768	Divider For GN1/4 Pans 268x27 mm
27	14771	Divider For GN1/6 Pans 178x76 mm
28	10020	Filter 182 x 215 mm
29	10017	Dust Filter Cover
30	10039	Cover For Screw
31	13896	Probe NTC Dixell/Carel 10 Kohm

2023-01-16

16499 / VK33-120 S/S LID

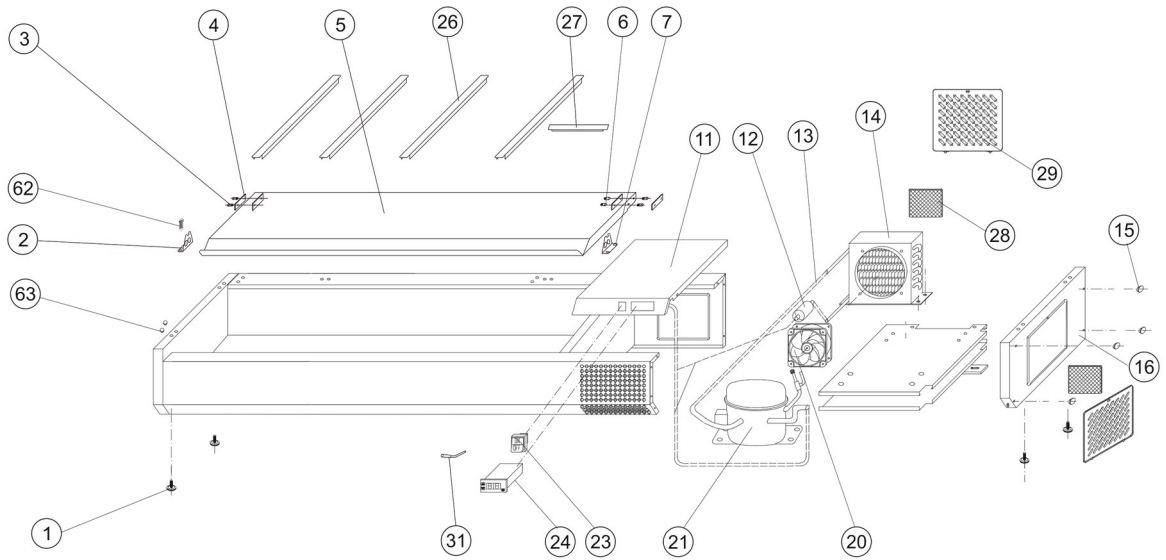

VK33-*nnn*-S/S Lid